

ME / YWW / KO / LYL /

SINGAPORE CHINESE GIRLS' SCHOOL  
SECOND SEMESTRAL ASSESSMENT 2018

PRIMARY 4  
MATHEMATICS  
BOOKLET A

Name : \_\_\_\_\_ (     )

19 October 2018

Class : Primary 4 SY/C/G/SE/P

Parent's Signature

There are 15 questions in this booklet.  
SECTION A

Total Time : 1 h 45 min (Booklet A and B)

**INSTRUCTIONS TO CANDIDATES**

DO NOT OPEN THIS BOOKLET UNTIL YOU ARE TOLD TO DO SO.

FOLLOW ALL INSTRUCTIONS CAREFULLY.

ANSWER ALL QUESTIONS.

CHECK THAT ALL MCQ ANSWERS ARE SHADED CORRECTLY IN THE OAS

This question paper consists of 5 printed pages.

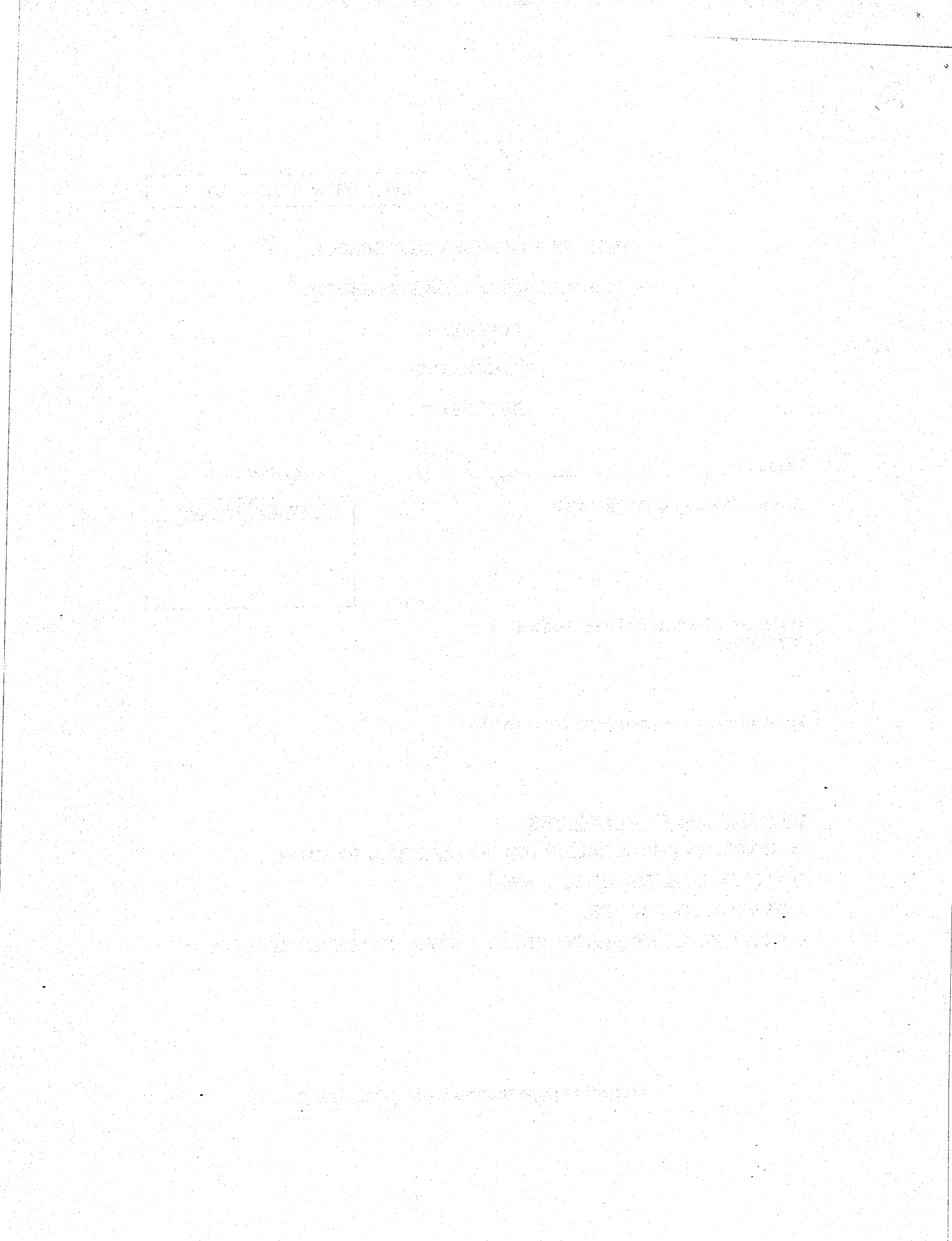

**Section A: ( 30 marks )**

Questions 1 to 15 carry 2 marks each. For each question, four options are given. One of them is the correct answer. Make your choice (1, 2, 3 or 4). Shade the correct oval (1, 2, 3 or 4) on the Optical Answer Sheet.

1. The value of the digit 9 in 59 216 is \_\_\_\_\_.

- (1) 90
- (2) 900
- (3) 9000
- (4) 90 000

2.  $90\ 000 + 1000 + 700 + 4 =$  \_\_\_\_\_.

- (1) 90 174
- (2) 91 704
- (3) 91 740
- (4) 91 744

3. Which of the following is a multiple of both 5 and 6?

- (1) 11
- (2) 24
- (3) 25
- (4) 30

4. Which of the following is **not** an equivalent fraction of  $\frac{1}{4}$ ?

- (1)  $\frac{2}{8}$
- (2)  $\frac{3}{12}$
- (3)  $\frac{5}{16}$
- (4)  $\frac{6}{24}$

5. What fraction of the shapes in the box are  ?

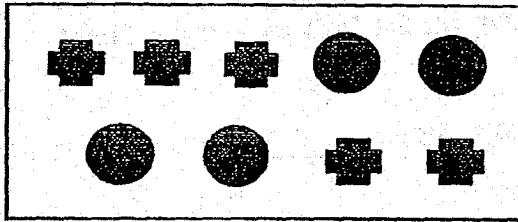

- (1)  $\frac{4}{9}$
- (2)  $\frac{4}{5}$
- (3)  $\frac{5}{9}$
- (4)  $\frac{5}{4}$

6. Which of the following decimals is represented by the letter A on the number line?

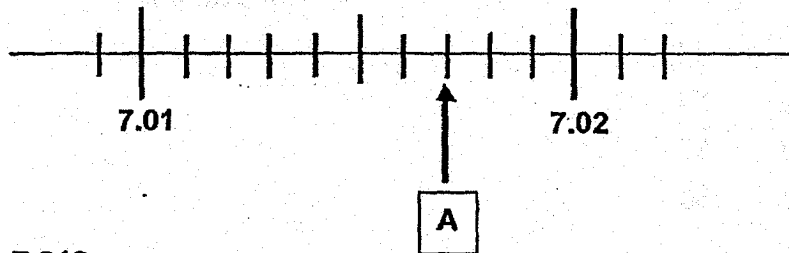

- (1) 7.012
- (2) 7.017
- (3) 7.023
- (4) 7.027

7. Express  $4\frac{7}{20}$  as a decimal

- (1) 4.7
- (2) 4.72
- (3) 4.35
- (4) 4.035

8. Mary bought a mug for \$2.75 and a teapot for \$19.90. She gave the cashier \$50. How much change did she get?

- (1) \$22.65
- (2) \$22.70
- (3) \$27.30
- (4) \$27.35

9. Jane bought 25 kg of flour. She used 0.96 kg of it to make some cookies. She packed the remaining flour equally into 4 bags. What was the mass of flour in each bag?

- (1) 6.01 kg
- (2) 6.1 kg
- (3) 6.16 kg
- (4) 6.61 kg

10. A file costs twice as much as a pen. Ava paid \$3.90 for 1 file and 4 pens. How much did Ava pay for each pen?

- (1) \$0.65
- (2) \$0.78
- (3) \$1.30
- (4) \$2.60

11. A  $\frac{3}{4}$  turn = \_\_\_\_\_°

- (1) 120°
- (2) 180°
- (3) 270°
- (4) 360°

12. The figure below is not drawn to scale. ABCD is a rectangle. Find  $\angle k$ .

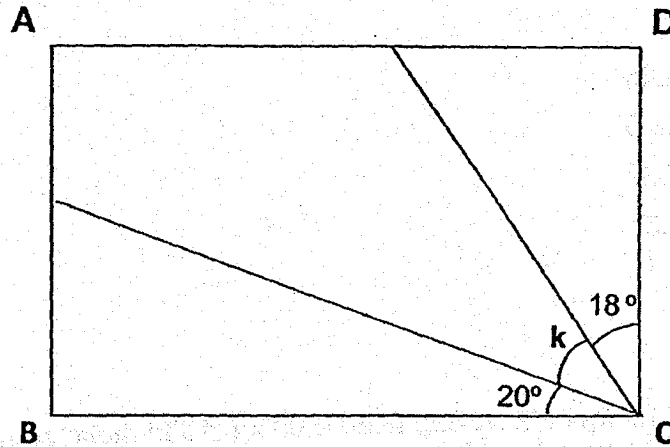

- (1)  $27^\circ$   
(2)  $52^\circ$   
(3)  $70^\circ$   
(4)  $72^\circ$
13. Lisa's ballet lesson started at 1.45 p.m.  
Her ballet lesson ended at 3.15 p.m.  
How long was her ballet lesson?

- (1) 1 h 30 min  
(2) 2 h  
(3) 3 h  
(4) 2 h 30 min

14. Figure below is made up of a rectangle EFHG and a square HIJK.  $FK = KH$ . Find the length of EG.

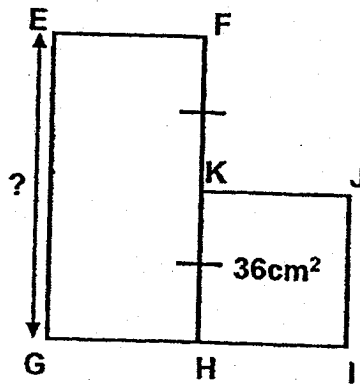

- (1) 6 cm  
 (2) 9 cm  
 (3) 12 cm  
 (4) 16 cm

15. Choose the improper fraction to represent the shaded parts below.

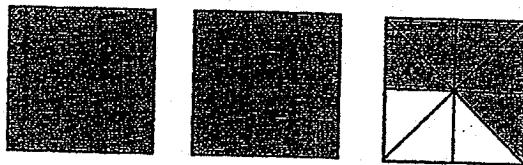

- (1)  $\frac{13}{8}$   
 (2)  $\frac{16}{8}$   
 (3)  $\frac{19}{8}$   
 (4)  $\frac{21}{8}$

THE UNIVERSITY OF CHICAGO PRESS

THE UNIVERSITY OF CHICAGO PRESS



ME / YWW / KO / LYL /

SINGAPORE CHINESE GIRLS' SCHOOL  
SECOND SEMESTRAL ASSESSMENT 2018

PRIMARY 4  
MATHEMATICS  
BOOKLET B

Name : \_\_\_\_\_ (     )

19 October 2018

Class : Primary 4 SY/C/G/SE/P

		Marks attained	Max Mark	Parent's Signature
Booklet A	Section A		30	
Booklet B	Section B		40	
	Section C		30	
Total			100	

There are 28 questions in this booklet.  
SECTION B and C

Total Time : 1 h 45 min (Booklet A and B)

**INSTRUCTIONS TO CANDIDATES**

DO NOT OPEN THIS BOOKLET UNTIL YOU ARE TOLD TO DO SO.  
FOLLOW ALL INSTRUCTIONS CAREFULLY.  
ANSWER ALL QUESTIONS.

This question paper consists of 11 printed pages.

THE  
 NATIONAL BUREAU OF INVESTIGATION  
 DEPARTMENT OF JUSTICE  
 WASHINGTON, D. C. 20535

NAME	TITLE	ORGANIZATION	ADDRESS

This report contains information that is confidential and should be handled accordingly.

The information contained herein is for your use only and should not be disseminated outside your organization.

If you have any questions regarding this report, please contact the source of the information.

Thank you for your cooperation.

**Section B: ( 40 marks )**

**Questions 16 to 35 carry 2 marks each. Write your answers in the space provided. For questions which require units, give your answers in the units stated.**

Do not write  
in this column

16. Write five thousand and twelve in figures.

Ans: \_\_\_\_\_

17. Arrange the following numbers from the smallest to the greatest.

9705 , 9057 , 9570

Ans: \_\_\_\_\_ , \_\_\_\_\_ , \_\_\_\_\_  
(smallest) (greatest)

18. Some factors of 24 are 1, 2, 3, 4, 6 and 24. What are the other two factors of 24?

Ans : \_\_\_\_\_ and \_\_\_\_\_

19. Which two of the fractions below are smaller than  $\frac{1}{2}$ ?

$\frac{2}{4}$  ,  $\frac{3}{5}$  ,  $\frac{4}{9}$  ,  $\frac{5}{12}$

Ans : \_\_\_\_\_ and \_\_\_\_\_

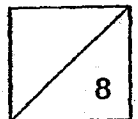

20. What is the value of  $\frac{5}{9} + \frac{2}{3}$ ?  
Express your answer as a mixed number.

Do not write  
in this column

Ans: \_\_\_\_\_

21. Round 12.65 to the nearest whole number.

Ans: \_\_\_\_\_

22.  $5.3 - 0.89 =$  \_\_\_\_\_

Ans: \_\_\_\_\_

23. In the figure below, name the two angles that are smaller than  $90^\circ$ .

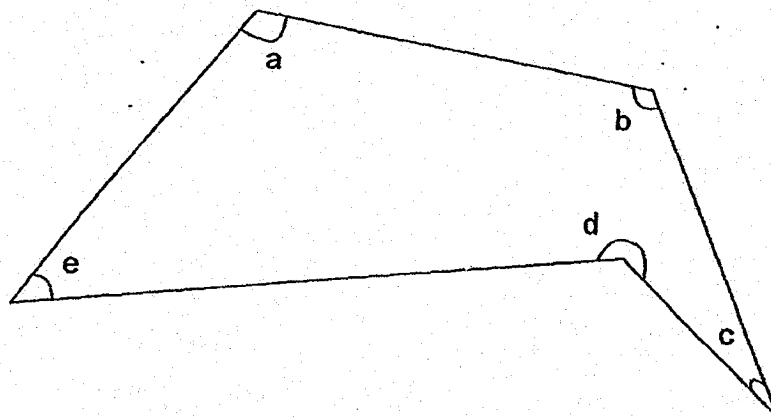

Ans:  $\angle$  \_\_\_\_\_ and  $\angle$  \_\_\_\_\_

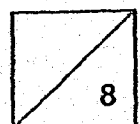

24. Measure and write down the size of  $\angle x$ .

Do not write  
in this column.

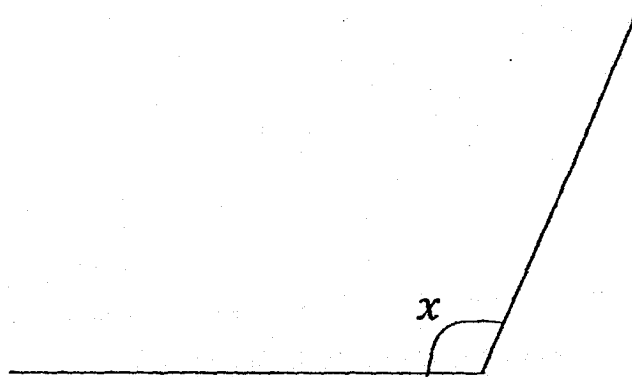

Ans: \_\_\_\_\_°

25. The price of 3 egg tarts is \$2.10.  
What is the cost of 8 such egg tarts?



Ans: \$ \_\_\_\_\_

26. Uncle Jack bought 63 boxes of pens. There were 9 pens in each box.  
He repacked the pens into smaller packets of 5 each.  
How many pens were left unpacked?

Ans: \_\_\_\_\_

Do not write  
in this column

27. Jenna read  $\frac{3}{8}$  of her book on Saturday. She had 105 pages left to read.  
How many pages are there in the book?

Ans: \_\_\_\_\_

28. Some water was poured out from a tank into 7 bottles.  
Each bottle contained 0.5 l of water. 2.4 l of water was left in the tank.  
How much water was there in the tank at first?

Ans: \_\_\_\_\_ l

29. The figure below is a square of side 16 cm.  
A small square of side 2 cm is cut out from each corner of the square.  
What is the perimeter of the shaded figure?

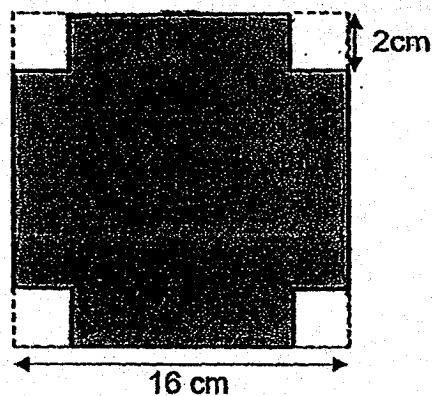

Ans: \_\_\_\_\_ cm

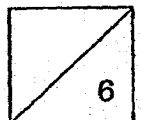

30. Complete the diagram below to form a symmetric figure.  
The dotted line is the line of symmetry. Draw the other half.

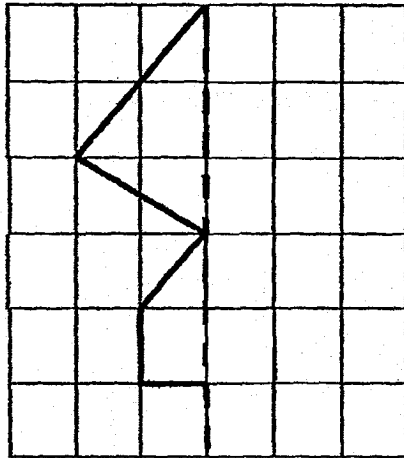

Do not write  
in this column

31. Mr Li travelled by train from Singapore to Penang. He left at 22 40. The journey took 12 h 55 min. What time did Mr Li arrive in Penang?

Ans: \_\_\_\_\_

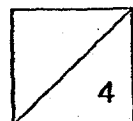

32. The following line graph shows the temperature at different times of a day at Sunny City

Do not write  
in this column.

Answer Questions 32 and 33.

Temperature at Sunny City

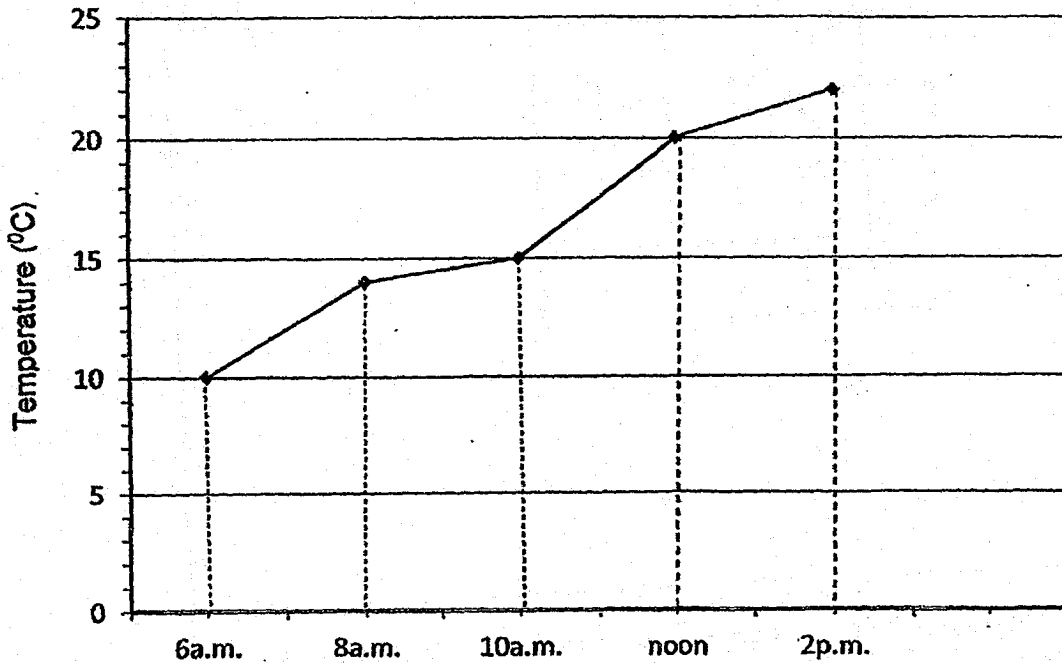

32. How much hotter was it at noon than at 6 a.m.?

Ans: \_\_\_\_\_ °C more

33. During which 2 hour interval did the temperature increase by 5°C?

Ans: \_\_\_\_\_ to \_\_\_\_\_

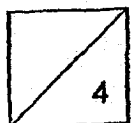



The table shows the amount of money spent by 4 children.  
 Answer questions 34 and 35.

Do not write  
 in this column.

Name	Amount spent (\$)
Alice	350
Betty	300
Candy	890
Diane	710

34. Please put a tick (✓) in the following boxes.

	True	False	Not possible to tell
The 4 children spent more than \$2000 altogether			

35. What is the difference between the greatest amount and the smallest amount spent?

Ans: \$ \_\_\_\_\_

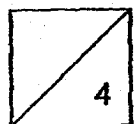

**Section C: ( 30 marks )**

For questions 36 to 43, show your working clearly in the space provided for each question and write your answer in the space provided.

The number of marks available is shown in brackets [ ] at the end of each question or part-question.

Do not write  
in this column

36. Danielle had 510 marbles. She had thrice as many marbles as Hannah. Danielle then gave Hannah some marbles so that both of them will have the same number of marbles. How many marbles will each of them have in the end?

Ans: \_\_\_\_\_ [ 3 ]

- 
37. Tom is 7 years old now. Jack is 4 years older than him. How old will Tom be when he is  $\frac{5}{7}$  of Jack's age?

Ans: \_\_\_\_\_ [ 3 ]

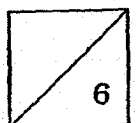

Do not write  
in this column

38. In a box there are 20¢ and 50¢ coins. There are 20 coins with a total value of \$6.40. Find the number of 20¢ coins.

Ans: \_\_\_\_\_ [4]

- 
39. Tank A has four times as much water as Tank B. When Jenny adds 1.9 ℓ of water to Tank A and 3.4 ℓ of water to Tank B, both tanks will have the same volume of water. Find the total volume of water in both tanks in the end.

Ans: \_\_\_\_\_ [4]

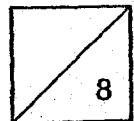

Do not write  
in this column

40. Natalie wanted to buy 20 doughnuts. If she buys 1 doughnut, it will cost \$2 and if she buys a box of 6 doughnuts, it will cost \$9. What is the least amount of money Natalie has to spend to buy 20 doughnuts?

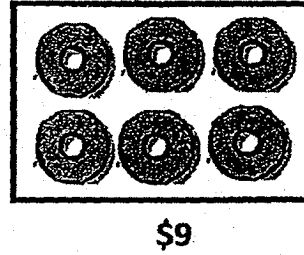
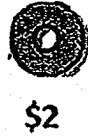

Ans: \_\_\_\_\_ [4]

41. Mr Tan's car was left with  $\frac{1}{4}$  fuel. He added 28 l of fuel to his car, it became  $\frac{5}{12}$  full. How much more fuel was needed to fill up Mr Tan's car?

Ans: \_\_\_\_\_ [4]

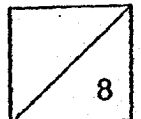

42.

When  $\frac{3}{4}$  of a bottle is filled with lemonade, it weighs 380g. When the bottle is half-filled with lemonade, it weighs 300g. Find the mass of the empty bottle.

Do not write  
in this colour

Ans: \_\_\_\_\_ [4]

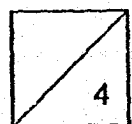

43. The figure below is not drawn to scale. A rectangular piece of paper is folded as shown below. Find
- length of the paper
  - area of the rectangular piece of paper

Do not write  
in this column

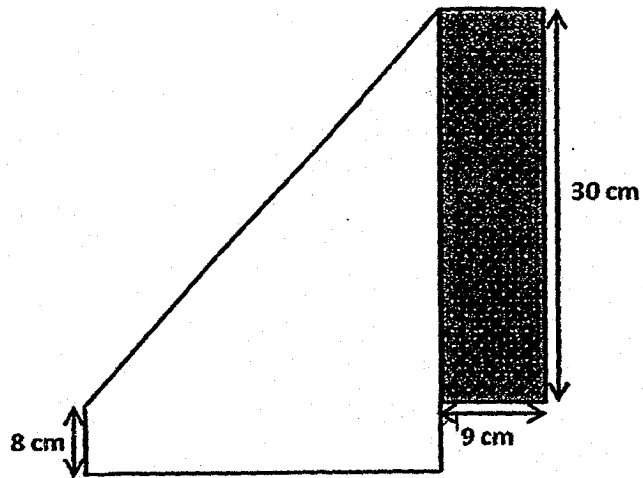

Ans:a) \_\_\_\_\_ [2]

b) \_\_\_\_\_ [2]

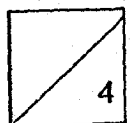

**END OF PAPER**

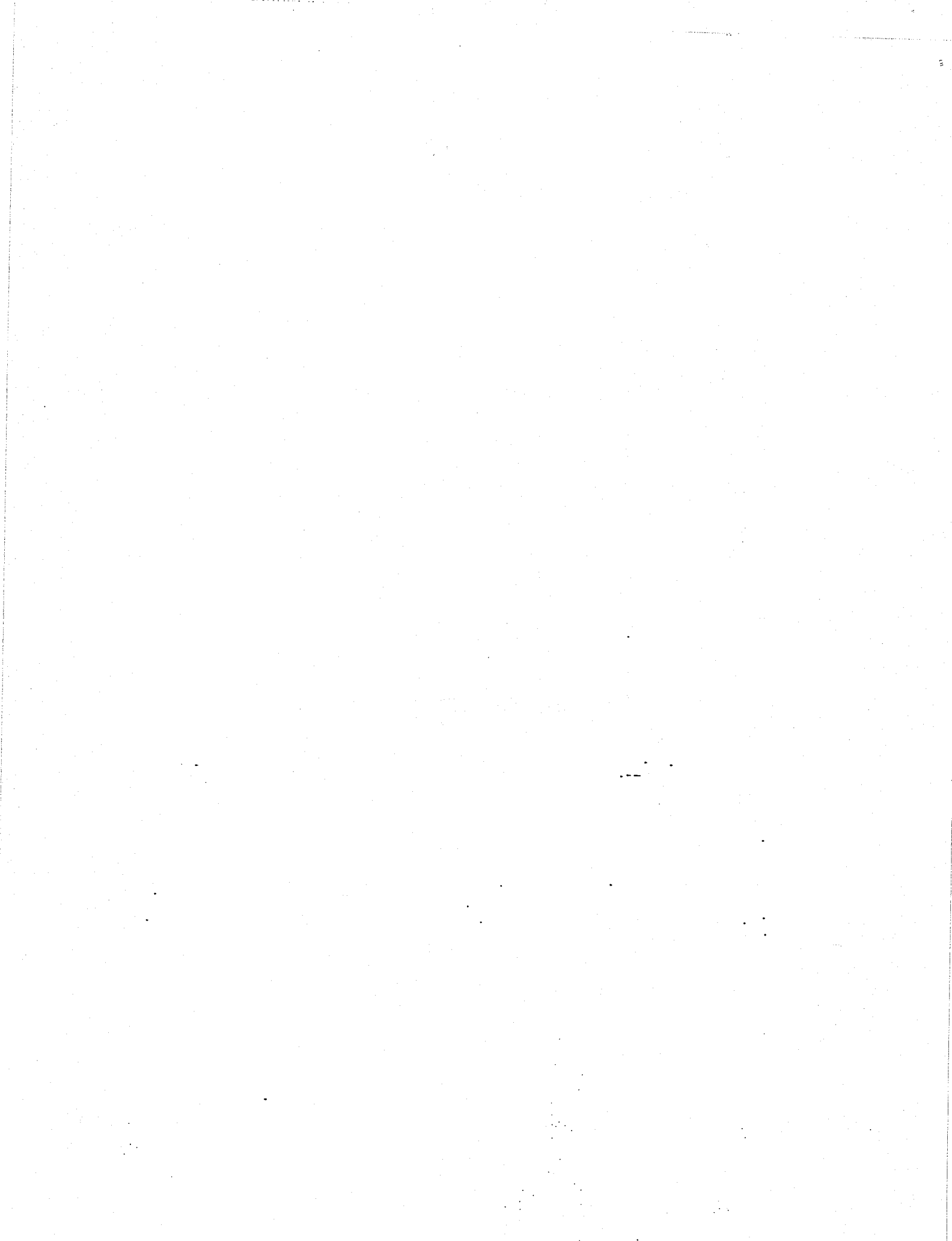



SINGAPORE CHINESE GIRLS' SCHOOL (PRIMARY)  
 Second SEMESTRAL ASSESSMENT 2018  
 PRIMARY 4  
 MATHEMATICS  
 ANSWER KEY FOR PUPILS

Section A

(1)	3	(6)	2	(11)	3
(2)	2	(7)	3	(12)	2
(3)	4	(8)	4	(13)	1
(4)	3	(9)	1	(14)	3
(5)	1	(10)	1	(15)	4

Section B

16) <u>5012</u>	17) <u>9057.9570.9705</u>
18) <u>8 and 12</u>	19) $\frac{4}{9}$ and $\frac{5}{12}$
20) $\frac{2}{9}$ , $1\frac{6}{27}$ or $1\frac{4}{18}$	21) <u>13</u>
22) <u>4.41</u>	23) $\angle e$ and $\angle f$
24) <u>1130</u>	25) $2.10 + 3 = \$0.70$ $\$0.70 \times 8 = \underline{\$5.60}$ Or 6 tarts --- $\$2.10 \times 2 = \$4.20$ 2 tarts --- $\$0.70 \times 2 = \$1.40$ 8 tarts --- $\$4.20 + \$1.40 = \$5.60$
26) $63 \times 9 = 567$ $567 + 5 = 113$ R 2 2 pens left	27) 5 units = 105 1 unit = $105 \div 5 = 21$ 8 units = $21 \times 8 = \underline{168}$
28) $0.5 \times 7 = 3.5$ € At first --- $(3.5 + 2.4)$ € = <u>5.9</u> € (M1, A1)	29) $16 \times 4 = \underline{64}$ cm

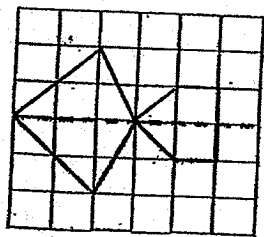

30)

31) Time line to show 11:35 a.m. (A2)

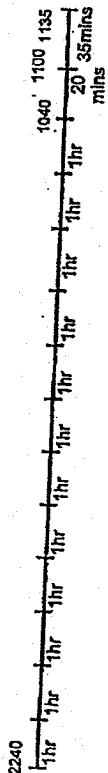

32)  $20^{\circ}\text{C} - 10^{\circ}\text{C} = 10^{\circ}\text{C}$

33) 10 a.m. to noon

34)  $\$710 + 300 + \$890 + \$350 = \$2250$   
True

35)  $\$890 - \$300 = \$590$

Section C

36)

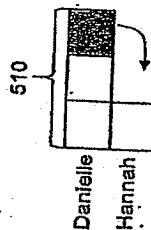

$3U = 510$   
 $1U = 510 \div 3 = 170$   
 $2U = 170 \times 2 = 340$

OR

$510 \div 6 = 85$   
 $85 \times 4 = 340$

37)

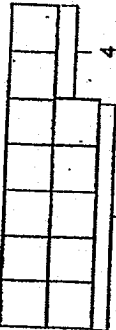

$2U = 4$   
 $1U = 4 \div 2 = 2$   
 $5U = 2 \times 5 = 10$

38) Method 1

$1 \times 20\phi = 20\phi$	$1 \times 50\phi = 50\phi$	Total	Check
$10 \times 20\phi = 200\phi = \$2.00$	$10 \times 50\phi = 500\phi = \$5.00$	\$7.00	X
$11 \times 20\phi = 220\phi = \$2.20$	$9 \times 50\phi = 450\phi = \$4.50$	\$6.70	X
$12 \times 20\phi = 240\phi = \$2.40$	$8 \times 50\phi = 400\phi = \$4.00$	\$6.40	✓

38) Method 2

Assumption method.  
Assume all coins are 50c coins.

Total value —  $50c \times 20 = \$10$

Difference —  $\$10 - \$6.40 = \$3.60$

Difference between one 50c and one 20c is 30c

No. of 20c coins —  $360 \div 30 = 12$

Or

Assumption method  
Assume all coins are 20c coins.

Total value —  $20c \times 20 = \$4$

Difference —  $\$6.40 - \$4 = \$2.40$

Difference between one 50c and one 20c is 30c

No. of 50c coins —  $240 \div 30 = 8$

No. of 20c coins —  $20 - 8 = 12$

39)

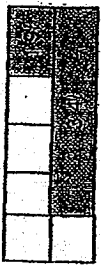

3 units  $\rightarrow 3.4 \text{ l} - 1.9 \text{ l} = 1.5 \text{ l}$   
 1 unit  $\rightarrow 1.5 \text{ l} \div 3 = 0.5 \text{ l}$   
 5 units  $\rightarrow 0.5 \text{ l} \times 5 = 2.5 \text{ l}$   
 Volume of water in each tank  $\rightarrow 2.5 \text{ l} + 3.4 \text{ l} + 1.9 \text{ l} = 7.8 \text{ l}$

40)

$20 = 18 + 2$   
 18 doughnuts  $\rightarrow 9 \times 3 = \$27$   
 Total amt  $\rightarrow \$27 + \$4 = \$31$

41)

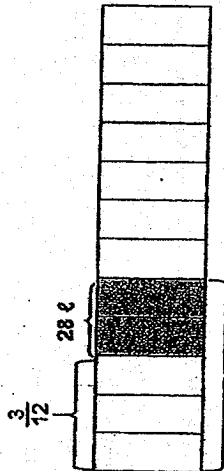

$\frac{1}{4} = \frac{3}{12}$   
 $5u - 3u = 2u$   
 $2u = 28 \text{ c}$   
 $1u = 28 \text{ c} \div 2 = 14 \text{ c}$   
 $7u = 14 \text{ c} \times 7 = 98 \text{ c}$

42)

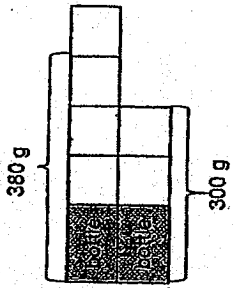

1u  $\rightarrow 80 \text{ g}$   
 2u  $\rightarrow 80 \times 2 = 160 \text{ g}$   
 Mass of pottle  $\rightarrow 300 - 160 = 140 \text{ g}$

Or

1u  $\rightarrow 80 \text{ g}$   
 3u  $\rightarrow 80 \text{ g} \times 3 = 240 \text{ g}$   
 Mass of bottle  $\rightarrow 380 - 240 = 140 \text{ g}$

43a) Length of paper  $\rightarrow 9 + 8 + 30 = 47 \text{ cm}$

43b) Area of paper  $\rightarrow 47 \times 30 = 1410 \text{ cm}^2$

**Section A: (30 marks)**

Questions 1 to 15 carry 2 marks each. For each question, four options are given. One of them is the correct answer. Make your choice (1, 2, 3 or 4). Shade the correct oval (1, 2, 3 or 4) on the Optical Answer Sheet.

1. The value of the digit 9 in 9216 is \_\_\_\_\_

- (1) 90  
 (2) 900  
 (3) 9000  
 (4) 90 000

2.  $90\ 000 + 1000 + 700 + 4 =$  \_\_\_\_\_

- (1) 90 174  
 (2) 91 704  
 (3) 91 740  
 (4) 91 744

3. Which of the following is a multiple of both 5 and 6?

- (1) 11  
 (2) 24  
 (3) 25  
 (4) 30

4. Which of the following is not an equivalent fraction of  $\frac{1}{4}$ ?

- (1)  $\frac{2}{8} = \frac{1}{4}$   
 (2)  $\frac{3}{12} = \frac{1}{4}$   
 (3)  $\frac{5}{16}$   
 (4)  $\frac{6}{24} = \frac{1}{4}$

5. What fraction of the shapes in the box are  ?

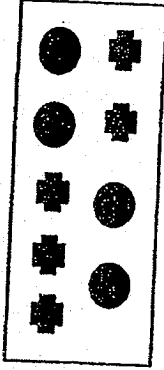

- (1)   $\frac{4}{9}$   
 (2)  $\frac{4}{5}$   
 (3)  $\frac{5}{9}$   
 (4)  $\frac{5}{4}$

6. Which of the following decimals is represented by the letter A on the number line?

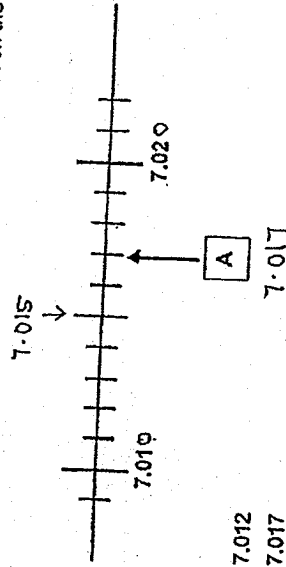

- (1) 7.012  
 (2) 7.017  
 (3) 7.023  
 (4) 7.027

7. Express  $4\frac{7}{20}$  as a decimal

$$4\frac{7}{20} \times \frac{5}{5} = 4\frac{35}{100} = 4.35$$

(1) 4.7  
 (2) 4.72  
 (3) 4.35  
 (4) 4.035

8. Mary bought a mug for \$2.75 and a teapot for \$19.90. She gave the cashier \$50. How much change did she get?

$$\begin{aligned} & \$2.75 + 19.90 = \$22.65 \\ & \$50.00 - 22.65 = \$27.35 \end{aligned}$$

- (1) \$22.65  
(2) \$22.70  
(3) \$27.30  
(4) \$27.35

9. Jane bought 25 kg of flour. She used 0.96 kg of it to make some cookies. She packed the remaining flour equally into 4 bags. What was the mass of flour in each bag?

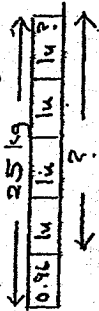

$$\begin{aligned} & 25 - 0.96 = 24.04 \\ & 4 \text{ — } 24.04 \\ & 1 \text{ — } 24.04 \div 4 = 6.01 \text{ kg} \end{aligned}$$

- (1) 6.01 kg  
(2) 6.1 kg  
(3) 6.16 kg  
(4) 6.61 kg

10. A file costs twice as much as a pen. Ava paid \$3.90 for 1 file and 4 pens. How much did Ava pay for each pen?

$$\begin{aligned} & \text{f} \quad \text{p} \\ & \begin{array}{|c|} \hline \cdot \\ \hline \cdot \\ \hline \cdot \\ \hline \cdot \\ \hline \cdot \\ \hline \end{array} \\ & 4 \text{ pens} \quad \left. \begin{array}{l} \text{ } \\ \text{ } \\ \text{ } \\ \text{ } \end{array} \right\} \$3.90 \\ & 6 \text{ — } \$3.90 \\ & 4 \text{ — } \$3.90 \div 4 \\ & = \$0.65 \end{aligned}$$

- (1) \$0.65  
(2) \$0.78  
(3) \$1.30  
(4) \$2.60

11. A  $\frac{3}{4}$  turn = \_\_\_\_\_°

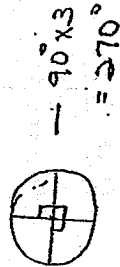

- (1) 120°  
(2) 180°  
(3) 270°  
(4) 360°

12. The figure below is not drawn to scale. ABCD is a rectangle. Find  $\angle k$ .

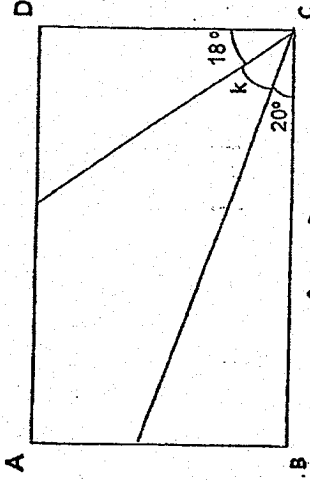

$$\begin{aligned} & 20^\circ + 18^\circ = 38^\circ \\ & \angle k = 90^\circ - 38^\circ \\ & = 52^\circ \end{aligned}$$

- (1) 27°  
(2) 52°  
(3) 70°  
(4) 72°

13. Lisa's ballet lesson started at 1.45 p.m. Her ballet lesson ended at 3.15 p.m. How long was her ballet lesson?

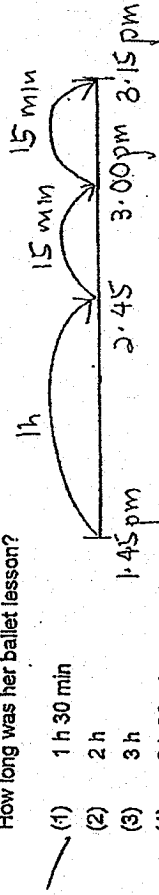

- (1) 1 h 30 min  
(2) 2 h  
(3) 3 h  
(4) 2 h 30 min

$$T - 1 \text{ h } 30 \text{ min}$$

14. Figure below is made up of a rectangle EFHG and a square HIJK. FK = KH. Find the length of EG.

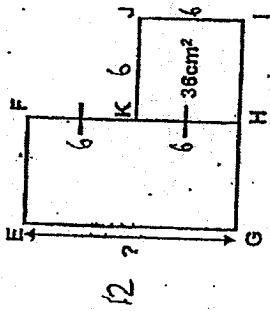

- (1) 6 cm  
 (2) 9 cm  
 (3) 12 cm  
 (4) 16 cm

$$6 \times 6 = 36$$

$$EG = 6 + L$$

$$= 12 \text{ cm}$$

15. Choose the improper fraction to represent the shaded parts below.

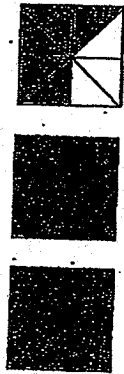

$$= \frac{5}{8}$$

(1)  $\frac{13}{8}$

(2)  $\frac{16}{8}$

(3)  $\frac{19}{8}$

(4)  $\frac{21}{8}$